



PRODUCT INFO

Part #: H2641W
System: H1 Series
Material: Aluminum
Fitment: Sprinter 2007-On (Low Roof)
Color: White

Fastens onto factory tracks (if available)

Tracks sold separately
Part# R20 / R21

REQUIRED TOOLS

Power Tool

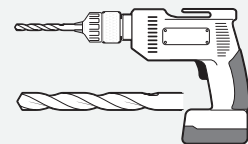







Phillips Head

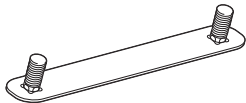
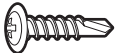

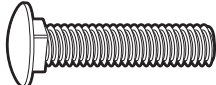
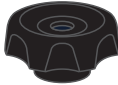
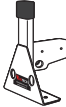
1/2" Wrench



PART#	DESCRIPTION	QTY	ITEM
S054	5/16" DOUBLE SLIDER	4	
B201	TAP SCREW	8	
N005	5/16" NYLON NUT	8	
W008	5/16" X 3/4" WASHER	8	
B018	5/16" X 1 3/4" CARRIAGE BOLT	2	
N016	5/16" KNOB	2	
H34	H1 MOUNTING BASE	4	
A613-57	2" X 1" X 57" CROSS BAR	2	
A02	LADDER GUIDE	1	
A06	LADDER STOPPER	1	
A69	EZ-HOOK & LOOP STRAP	1	
BG549	RUBBER BAR GUARD 49"	2	

items not drawn to scale

EZ Hook & Loop Strap

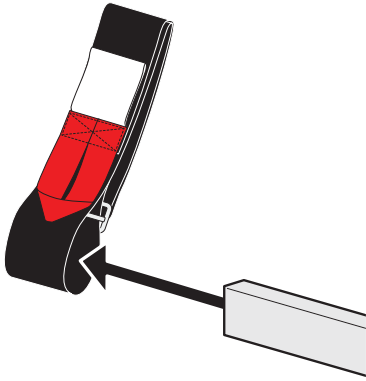

Directions

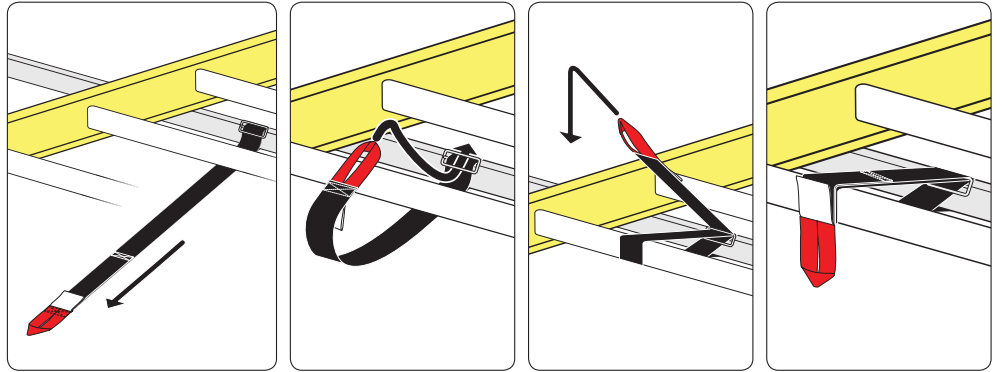

RUBBER BAR GUARDS

- Press the rubber bar guard into the channels of cross bars
- Leave 4" on each end

