

### PRODUCT INFO

---

Part #: H2642W  
System: H1 Series  
Material: Aluminum  
Fitment: Sprinter 2007-On (Low Roof)  
Color: White

Fastens onto factory tracks (if available)

Tracks sold seperately  
Part# R20 / R21

### REQUIRED TOOLS





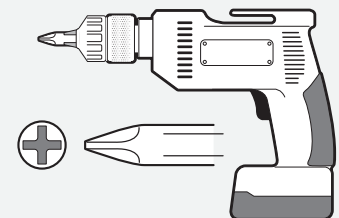

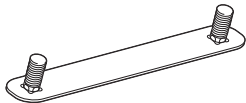
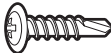

---

Power Tool With Phillips Head

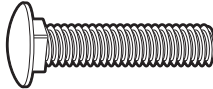
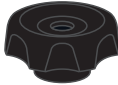

1/2" Wrench



| PART#   | DESCRIPTION                  | QTY | ITEM  |
|---------|------------------------------|-----|---|
| S054    | 5/16" DOUBLE SLIDER          | 6   |    |
| B201    | TAP SCREW                    | 12  |    |
| N005    | 5/16" NYLON NUT              | 12  |    |
| W008    | 5/16" X 3/4" WASHER          | 12  |    |
| B018    | 5/16" X 1 3/4" CARRIAGE BOLT | 4   |    |
| N016    | 5/16" KNOB                   | 4   |   |
| H34     | H1 MOUNTING BASE             | 6   |  |
| A613-57 | 2" X 1" X 57" CROSS BAR      | 3   |  |
| A02     | LADDER GUIDE                 | 2   |  |
| A06     | LADDER STOPPER               | 2   |  |
| A69     | EZ-HOOK & LOOP STRAP         | 2   |  |
| BG549   | RUBBER BAR GUARD 49"         | 3   |  |

items not drawn to scale

## EZ Hook & Loop Strap

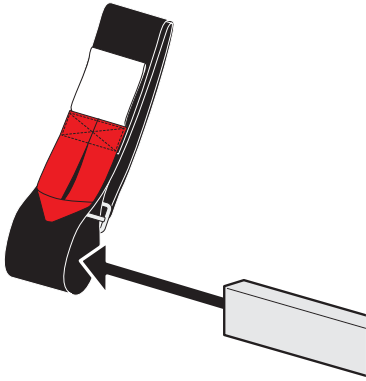

## Directions

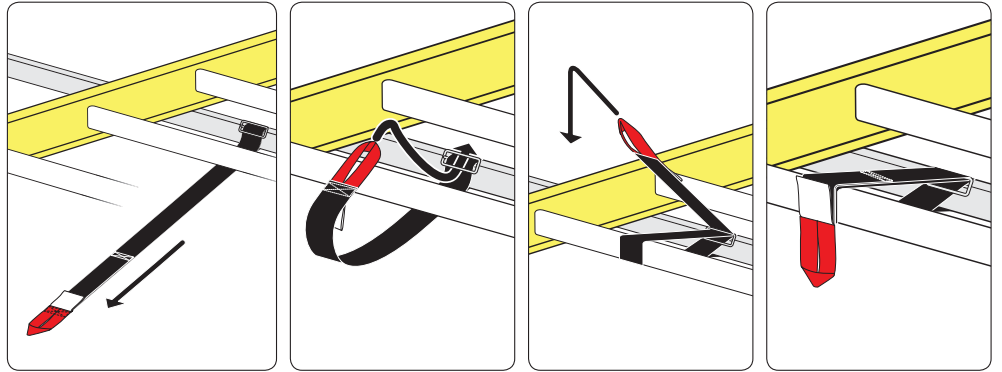

## RUBBER BAR GUARDS

- Press the rubber bar guard into the channels of cross bars
- Leave 4" on each end

