

# INSTALLATION GUIDE



## 1506-PHM Cargo Plus

RAM Promaster 136" Wheelbase



# PHASE 1 – ASSEMBLY

## 1.1 SETUP

1.1.2 Verify all parts are present.

### 15-U4004 BOX

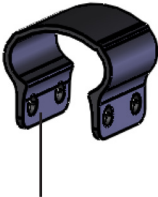

SADDLE EXTRUSION x6

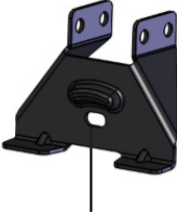

FOOT x6

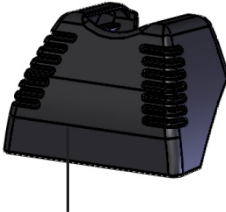

FOOT COWL x6



RUBBER SPACER x6

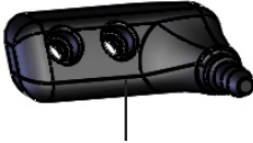

ROLLER SUPPORT "R" x1

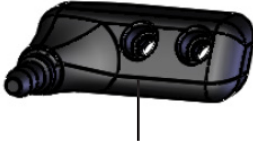

ROLLER SUPPORT "L" x1



FOOT CLAMP x6

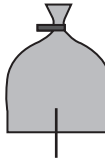

CFK - 1 x1

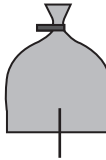

CFK - 2 x1

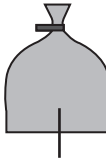

CFK - 3 x1

### 15-U1002 BOX

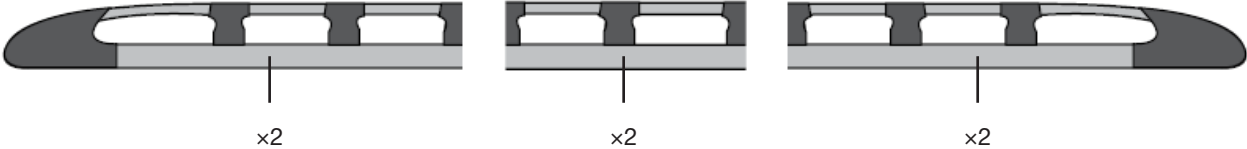

x2

x2

x2

### 15-U3002 BOX



BAR x3



ROLLER x1

### 15-U2002 BOX



BAR x6

# HARDWARE

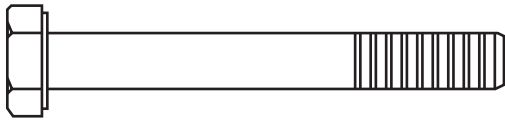

(M8 x 65) x12



(M8 x 40) x6



(M8) x34



(M8) x22

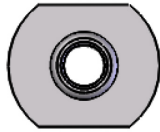

(M8) x22



(M8) x24



(M8) x12



(M8) x6

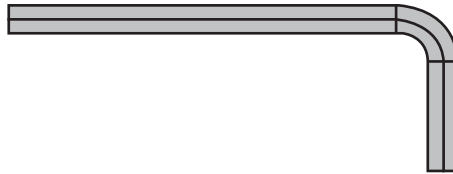

(M8) x1

# REQUIRED ITEMS

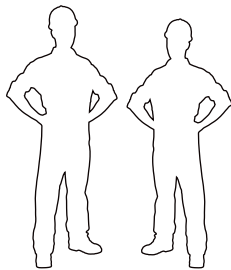

**2**  
**PERSONS**

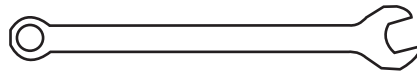

13mm x2

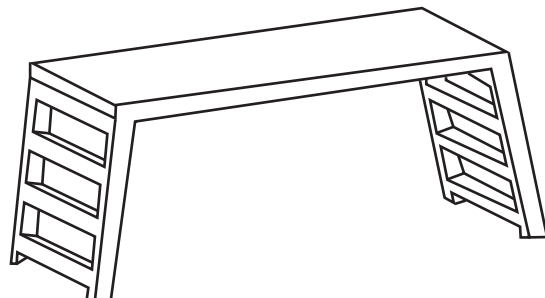

# PHASE 2 – INSTALLATION

## 2.1 INSTALLATION

### 2.1.1 Install the feet.

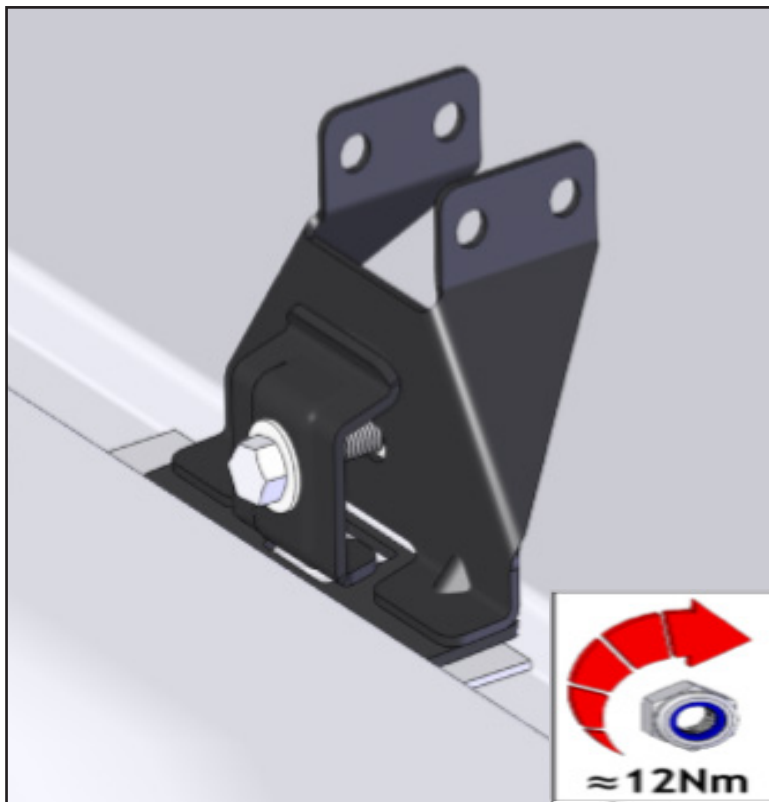
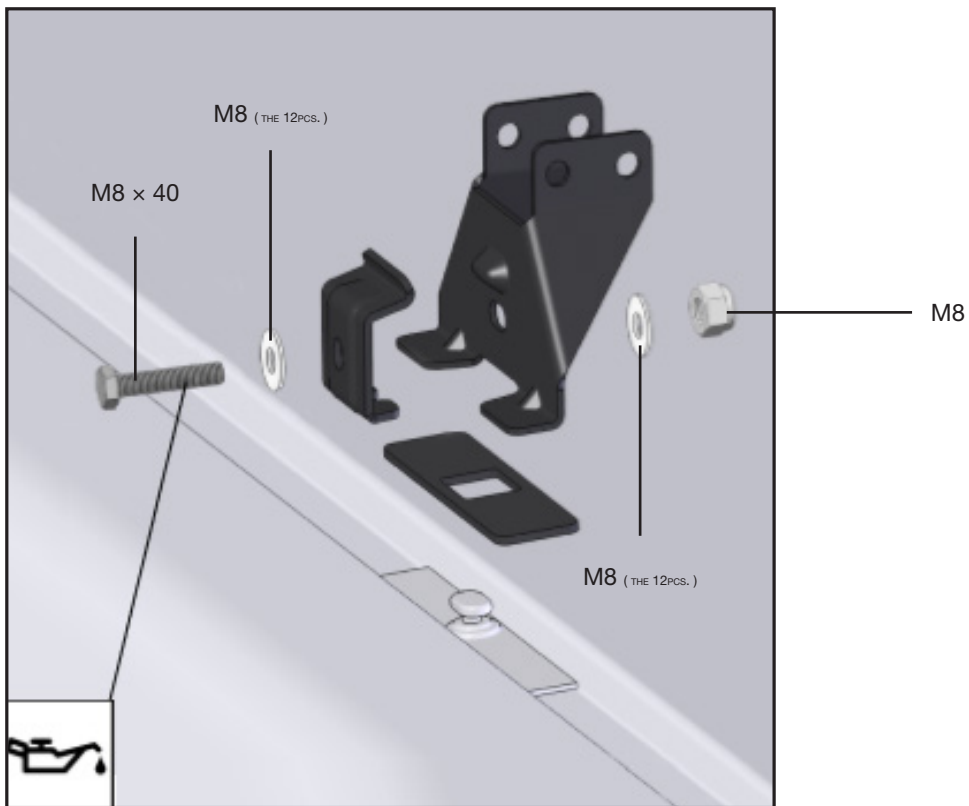

2.1.2 Connect the 3 side rails parts.

2x

STEP 1

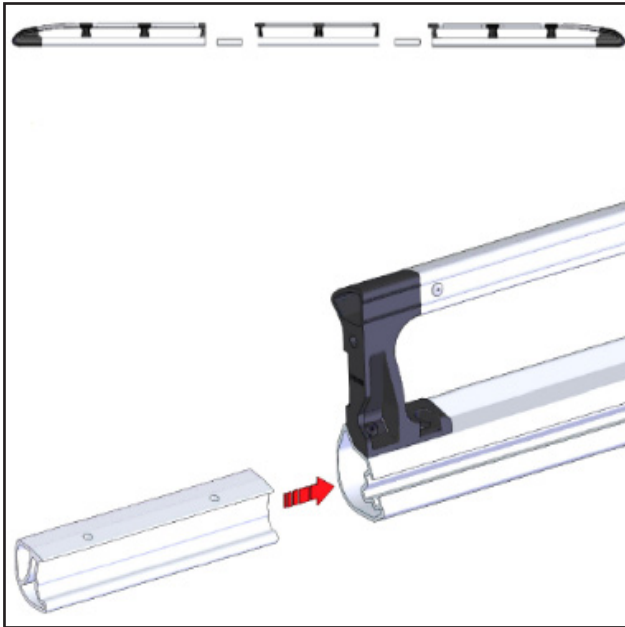

STEP 2

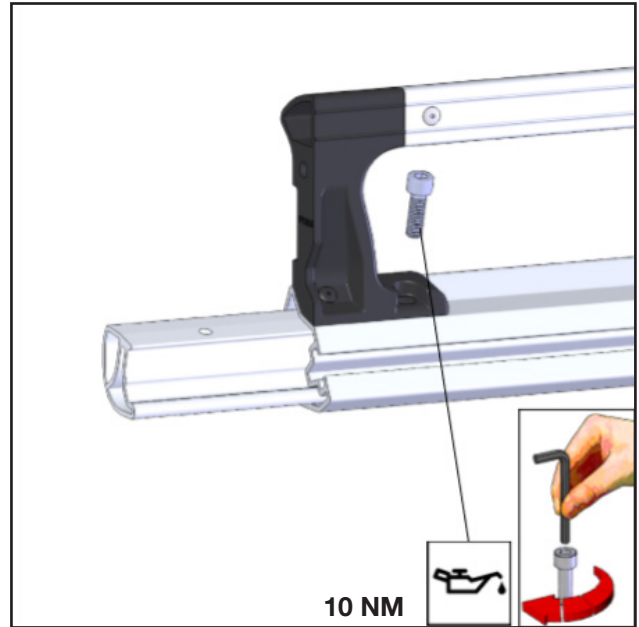

STEP 3

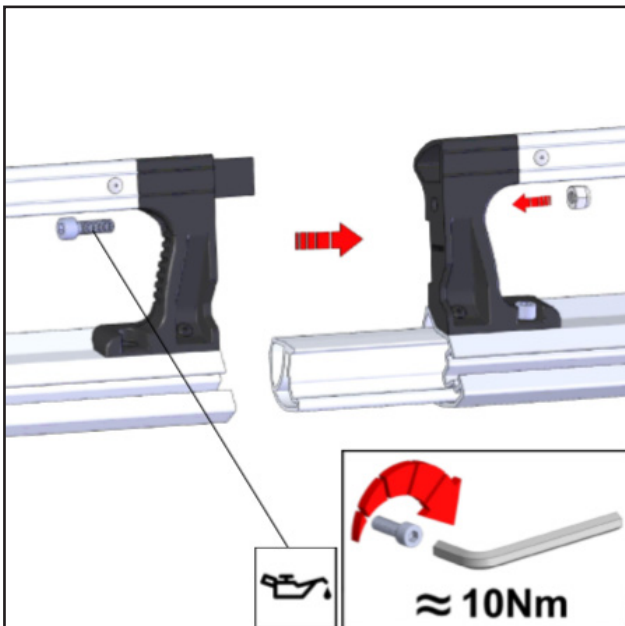

STEP 4

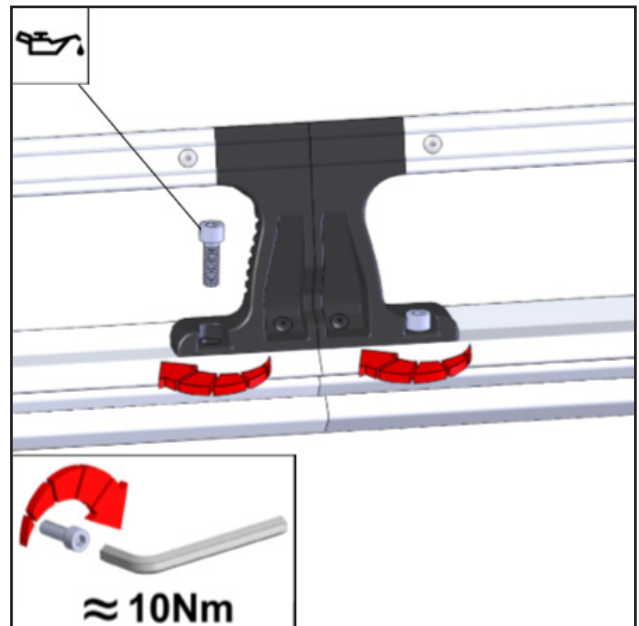

**2.1.3** Install 3 bars in the feet.

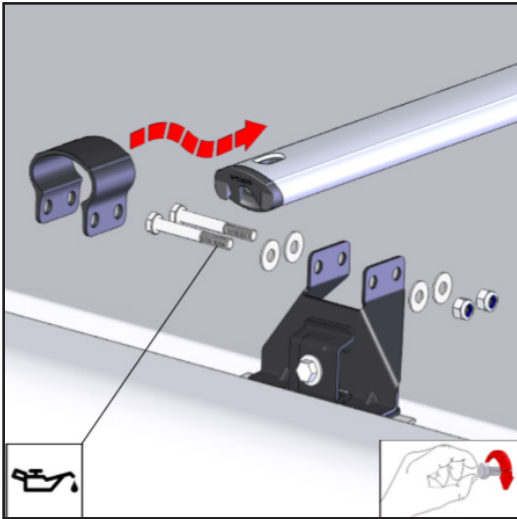

**2.1.4** Slide 11pcs. of channel nuts in each side rails.

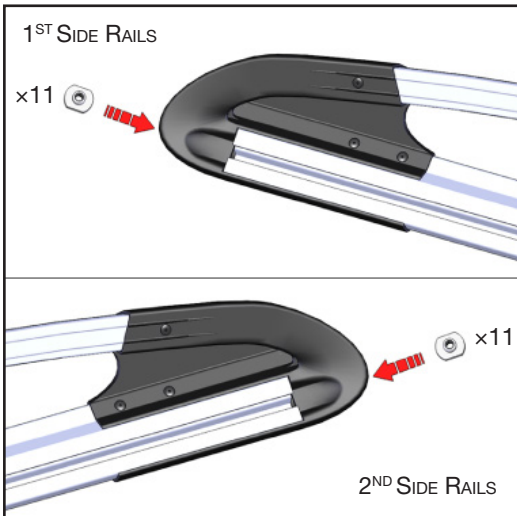

**2.1.5** Attach the 2 side rails on both ends of the bar, using the 2<sup>ND</sup>, 5<sup>TH</sup> & 8<sup>TH</sup> Channel nuts from the front.

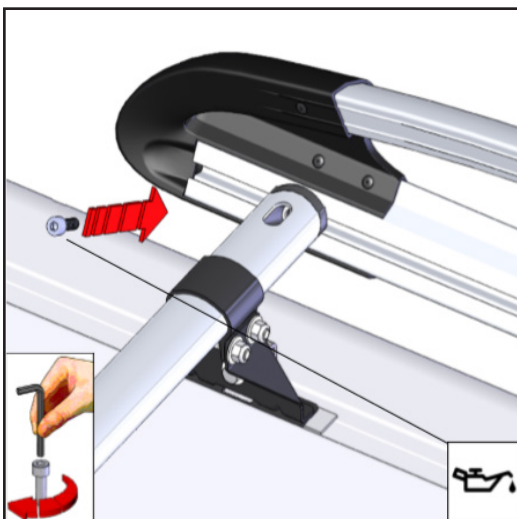

**2.1.6** Attach the roller to the side rails using the 2 last channel nuts from the front.

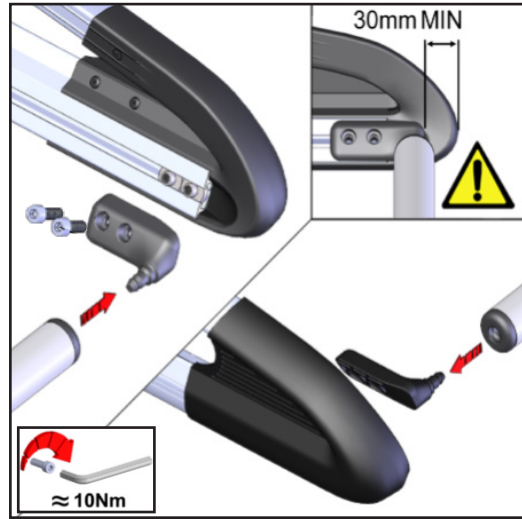

**2.1.7** Slide the rack to the appropriate position.

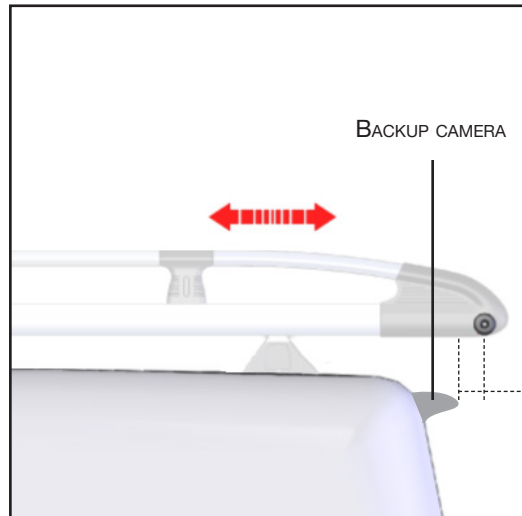

**2.1.8** Center the bar on the vehicle.

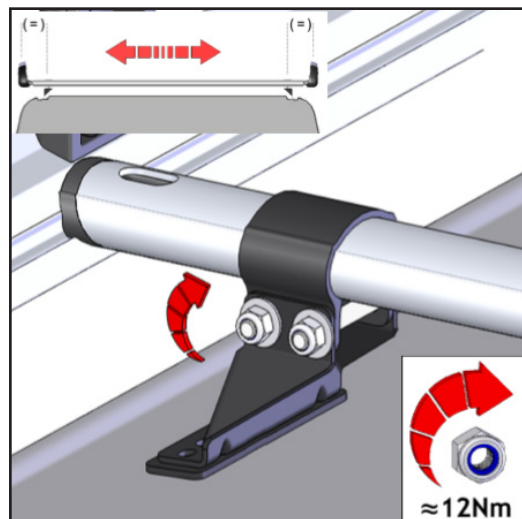

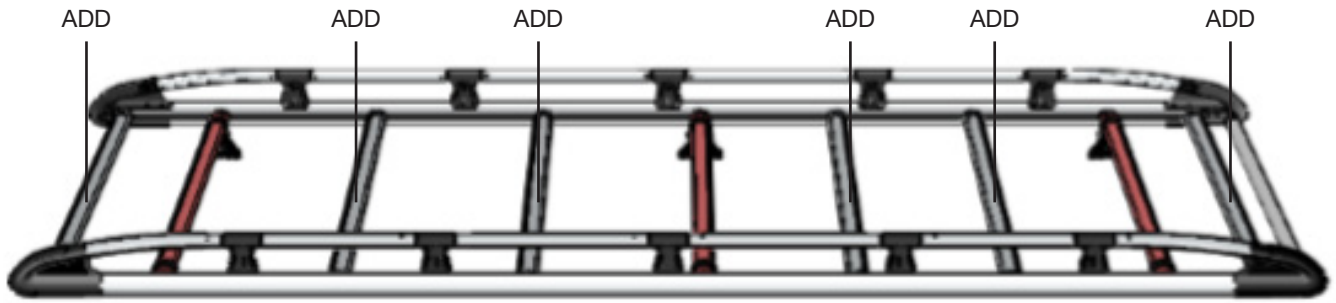

2.1.9 Attach the 6 bar.

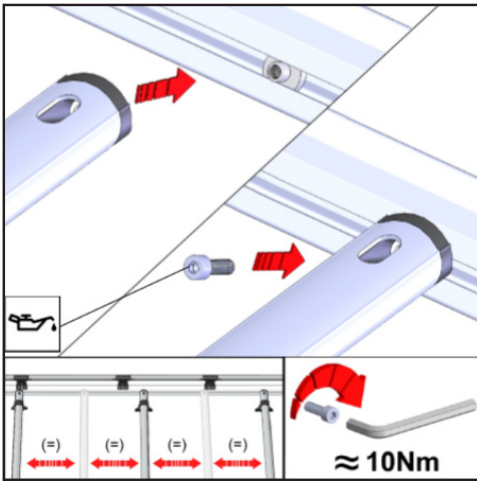

2.1.10 Attach the foot cowl to the foot.

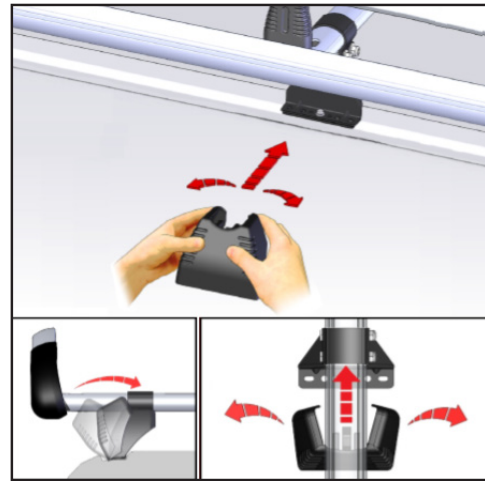

## PHASE 3 – TIPS

### 3.1 SAFETY TIPS

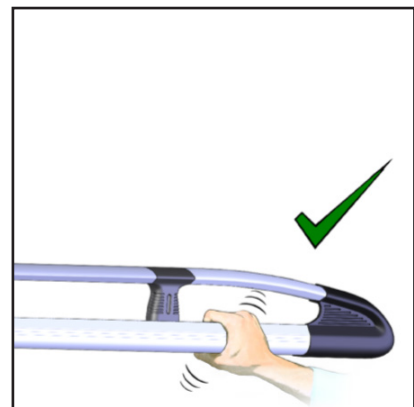
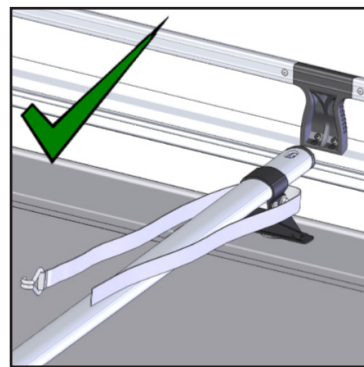
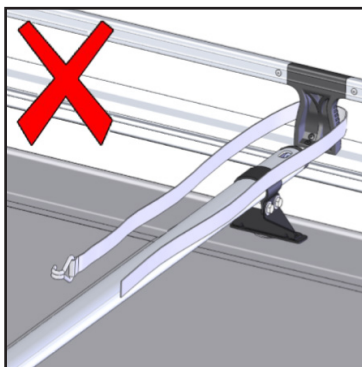
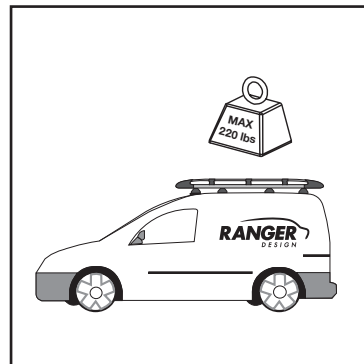
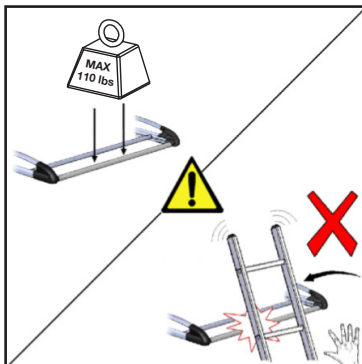

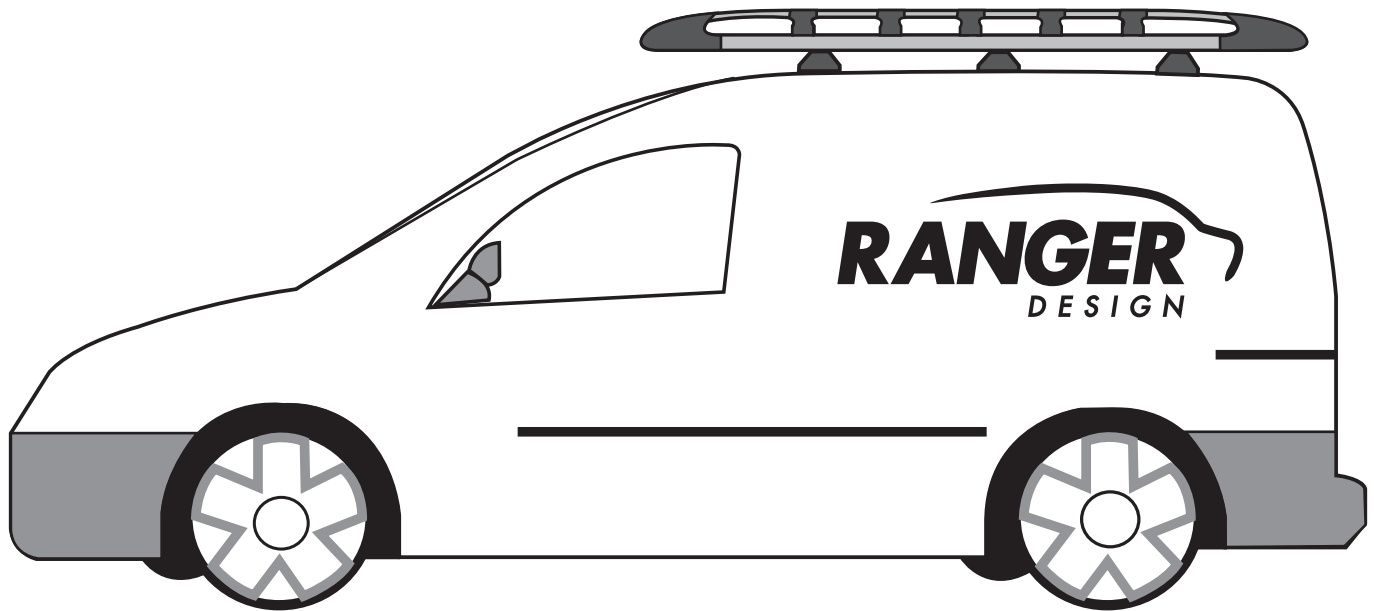

**“You have successfully installed your  
1506-PHS Cargo Plus**

**Thank you for doing business with us.”**

For any feedback or suggestions you may have, please contact: [cs@rangerdesign.com](mailto:cs@rangerdesign.com)

