

# LEGEND FLEET SOLUTIONS

## TRANSIT 148" EXTENDED HIGH ROOF WALL LINERS

### INSTALLATION INSTRUCTIONS



#### NOTES:

1. Before commencing, remove all wall liners and "D" Rings already installed in the vehicle.
2. Consult layout PDF and compare vehicle layout allocated Legend.
3. Prepare hardware shown below and have them ready for installation.
4. Wall liners will be installed in the order shown in the instructions.
5. A drill with a Phillips driver is required to install ( C ) #8 Screws, shown below.
6. Reinstall all "D" Rings once the wall liner kit installation is completed.

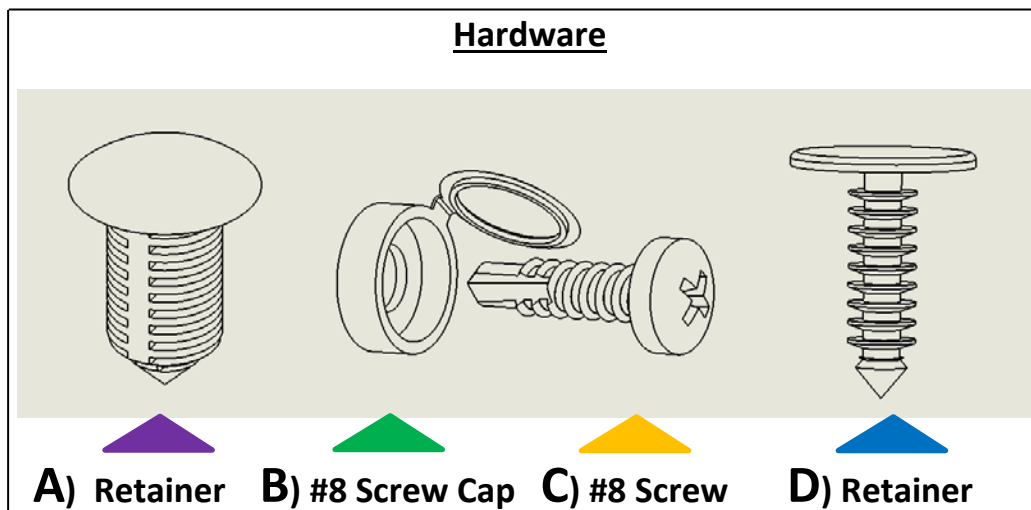

# TRANSIT 148" EXT. HIGH ROOF WALL LINERS

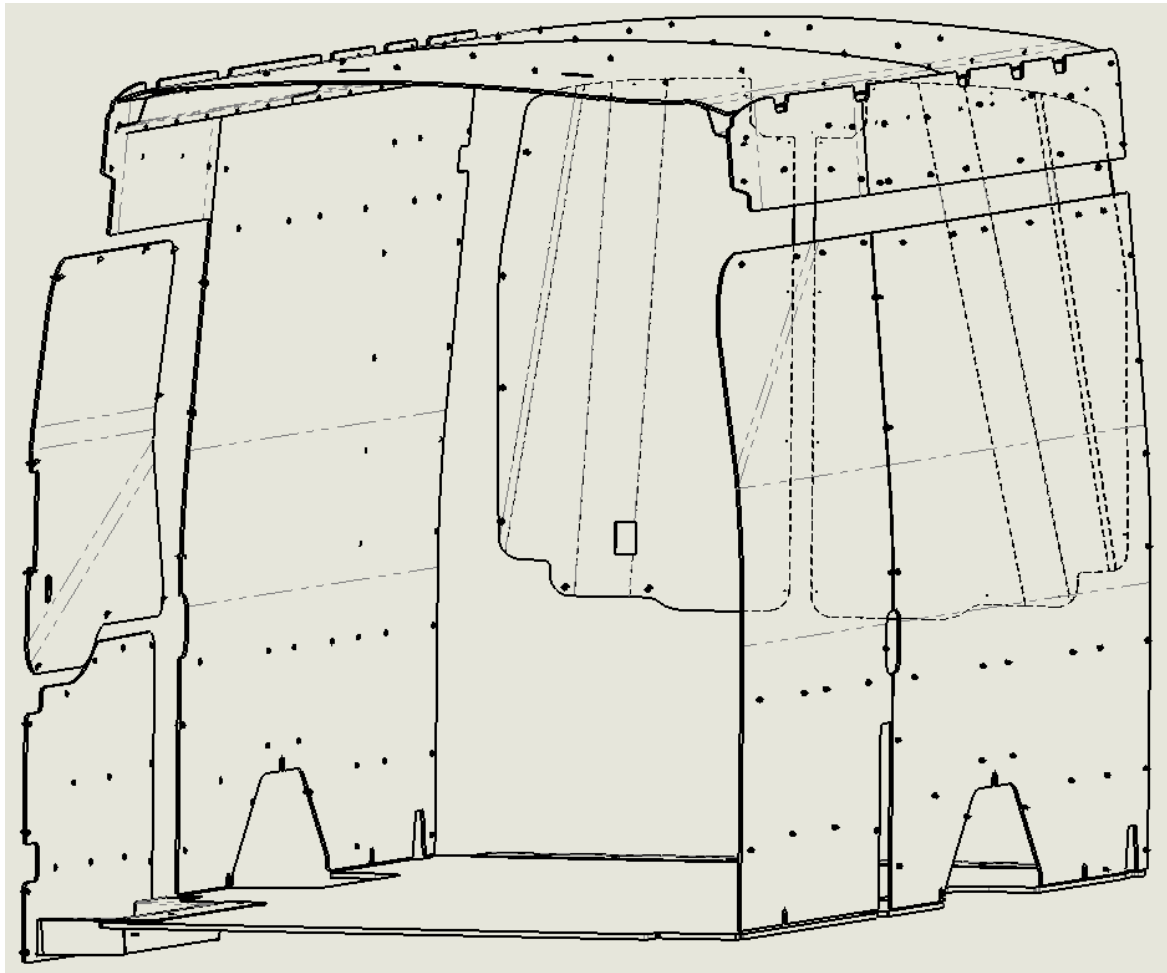

ITEM NO.	PART NUMBER	DESCRIPTION	QTY.
1	755-114-2613.HR	GREY CEILING FRONT PANEL TRANSIT 148" EXT HR	1
2	755-114-2613.HR	GREY CEILING BACK PANEL TRANSIT 148" EXT HR	1
3	RETAINER	RETAINER- BLACK NYLON	158
4	757-151-1010.HR	CEILING SILL A TRANSIT 148" EXT HR	1
5	757-151-1010.HR	CEILING SILL C TRANSIT 148" EXT HR	1
6	757-151-1010.HR	CEILING SILL B TRANSIT 148" EXT HR	1
7	757-151-1010.HR	CEILING SILL D TRANSIT 148" EXT HR	1
8	SCREW	SCREW - PHIL. PAN HD #8X.75 SELF DRILLING	76
9	757-151-1010.HR	CEILING SILL JOINER PLATE TRANSIT 148" EXT HR	2
10	753-114-2613.HR	GREY REAR UPPER DOOR PANEL PASSENGER SIDE TRANSIT 148" EXT HR	1
11	753-114-2613.HR	GREY REAR UPPER DOOR PANEL DRIVER SIDE TRANSIT 148" EXT HR	1
12	SCREW CAP	SCREW CAP	34
13	754-114-2613.HR	GREY REAR PANEL DRIVER SIDE TRANSIT 148" EXT HR	1
14	754-114-2613.HR	GREY REAR UPPER DRIVER SIDE PANEL TRANSIT 148" EXT HR	1
15	754-114-2613.HR	GREY REAR PANEL PASSENGER SIDE TRANSIT 148" EXT HR	1
16	752-xxx-6641	FLOOR TRANSIT 148" EXT. HR	1
17	RETAINER	RETAINER- BLACK NYLON 31163211	12
18	708-151-1011	FLOOR REAR SILL- TRANSIT	1
19	706-151-1011	FLOOR SLIDING DOOR SILL 3 - TRANSIT	1
20	706-151-1011	FLOOR SLIDING SILL 1- TRANSIT	1
21	709-151-1011	FLOOR SLIDING DOOR SILL 2 - TRANSIT	1
22	753-114-2613.HR	GREY SIDE DOOR TOP PANEL TRANSIT 148" EXT HR	1
23	753-114-2613.HR	GREY SIDE DOOR BOTTOM PANEL TRANSIT 148" EXT HR	1
24	754-114-2613.HR	GREY FRONT PANEL DRIVER SIDE TRANSIT 148" EXT HR	1
25	754-114-2613.HR	GREY FRONT UPPER DRIVER SIDE PANEL TRANSIT 148 EXT HR	1
26	754-114-2613.HR	GREY FRONT UPPER PASSENGER SIDE PANEL TRANSIT 148 EXT HR	1

## Driver Side Wall Liner Installation

ITEM 14  
REAR UPPER DRIVERS SIDE PANEL

ITEM 13  
REAR DRIVERS SIDE PANEL

ITEM 25  
FRONT UPPER DRIVERS SIDE PANEL

ITEM 24  
FRONT  
DRIVERS SIDE  
PANEL

REAR

FRONT

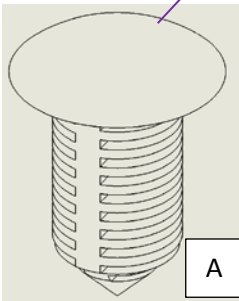

**1:** Install Item 24 and 25, Front Driver Side Panels.

- Align notch and edge of panel with the feature on the vehicle driver side front then align opposite side of panel edge with the contour features.
- Install hardware (A), in the holes provided, on the bottom of the panel first, working your way up the panel to the top.

**2:** Install Item 13 and 14, Rear Driver Side Panels.

- Align wheel well edge of the panel with the feature on the vehicle; position the contour of the panel to the vehicle wall.
- Install hardware (A), in the holes provided, on the bottom of the panel first, working your way up the panel to the top.

Installation completed

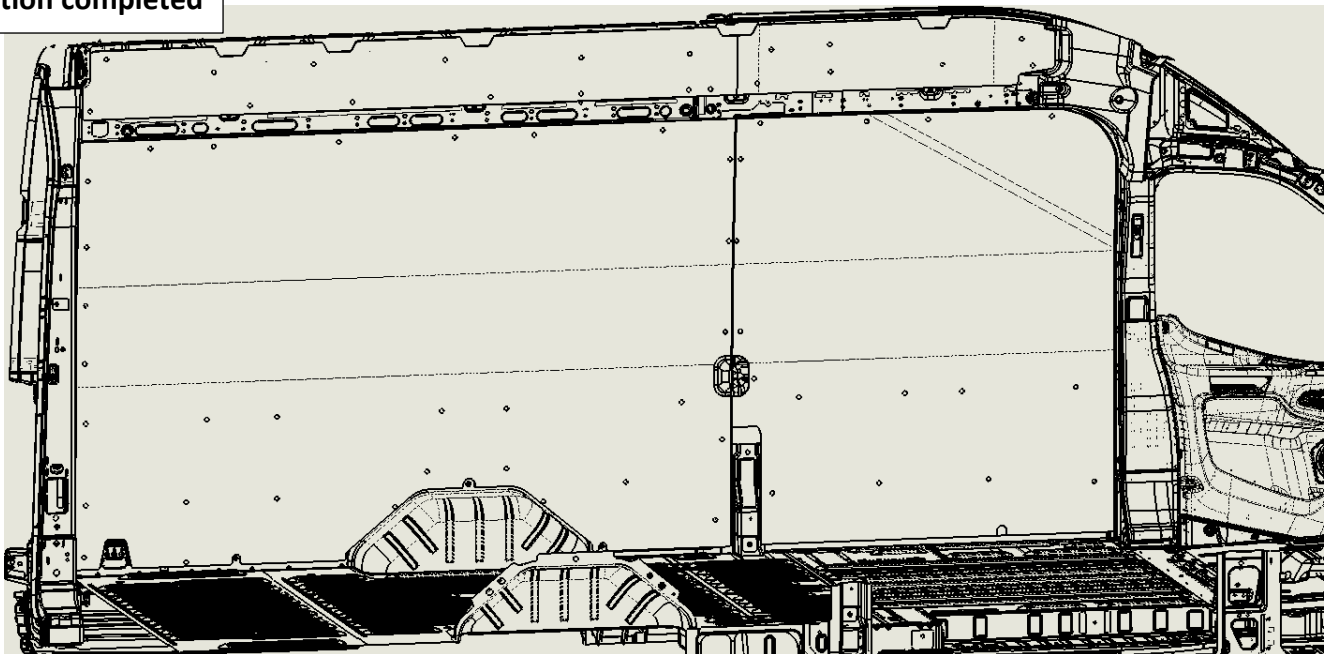

## Back Door Wall Liner Installation

### ITEM 10

UPPER REAR  
DOOR PASSENGER  
SIDE PANEL

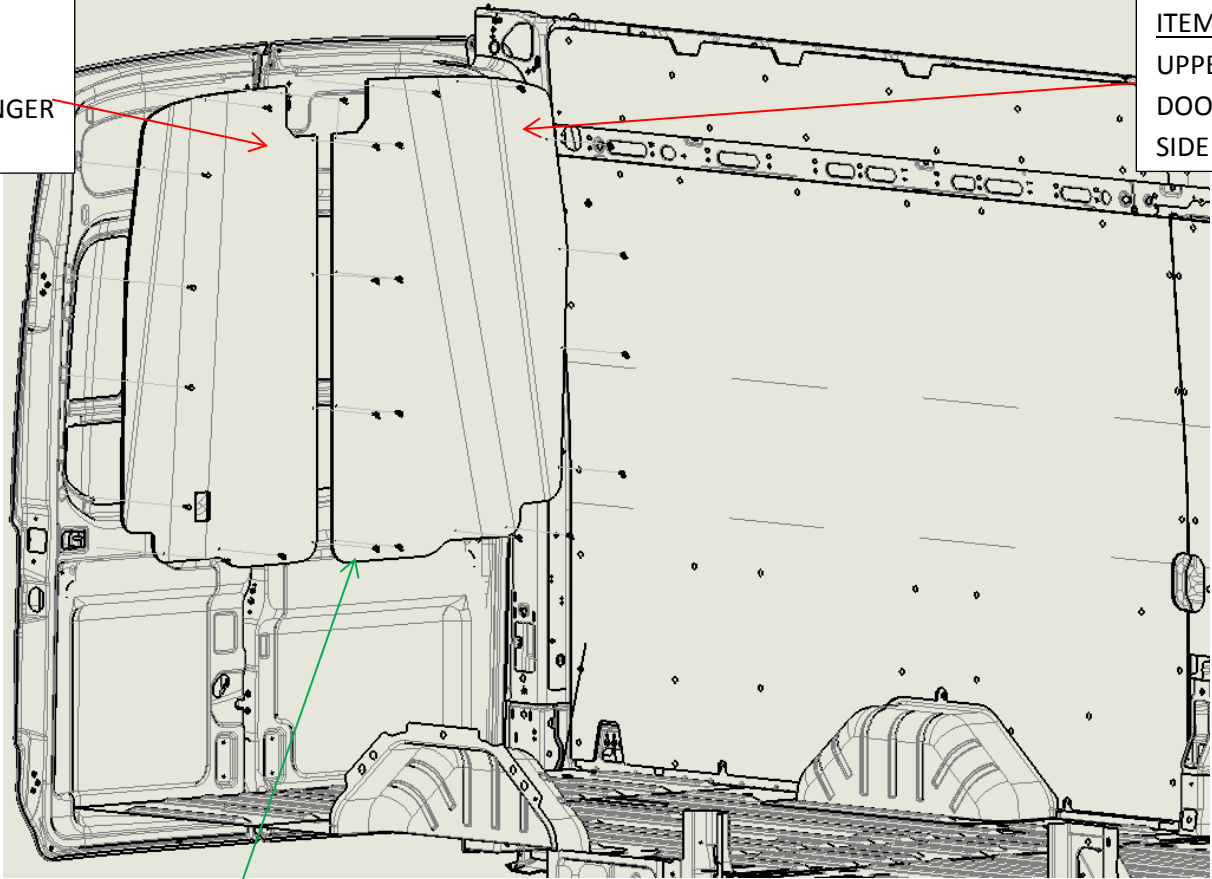

### ITEM 11

UPPER REAR  
DOOR DRIVERS  
SIDE PANEL

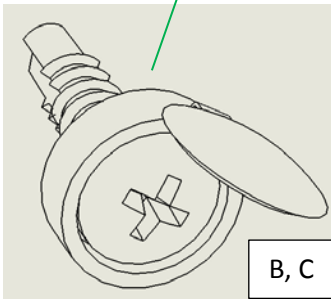

**3:** Install Item 10 and 11, Upper door panels,

- Align the Upper panels with the upper door contours.
- Install hardware (B, C), in the holes provided, on the top of the panel first, working your way down the panel to the bottom.

Installation completed

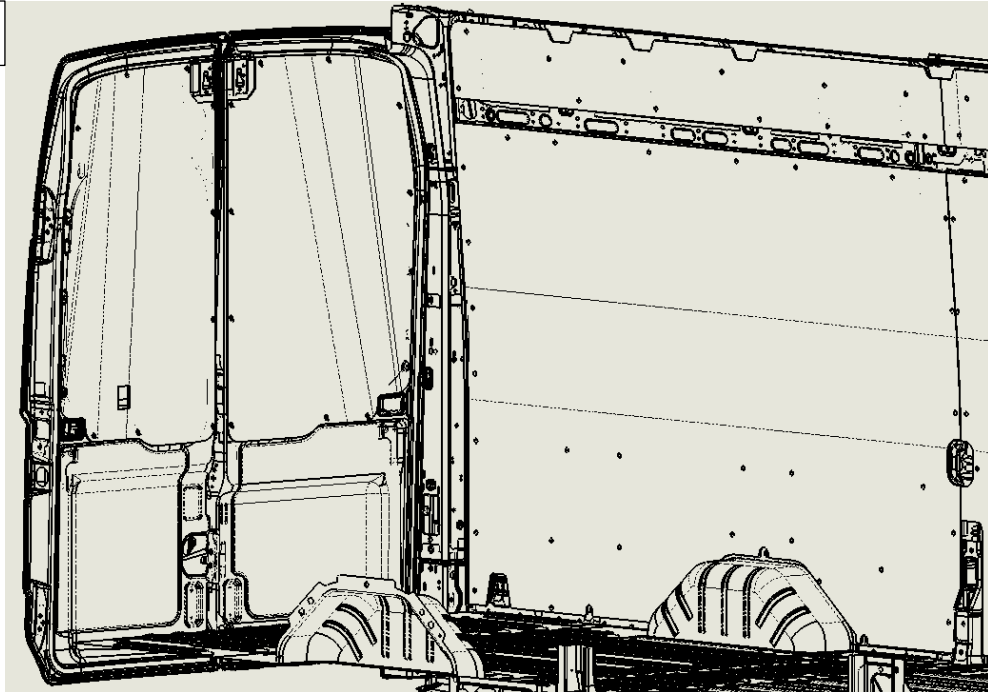

# Passenger Side Wall Liner Installation

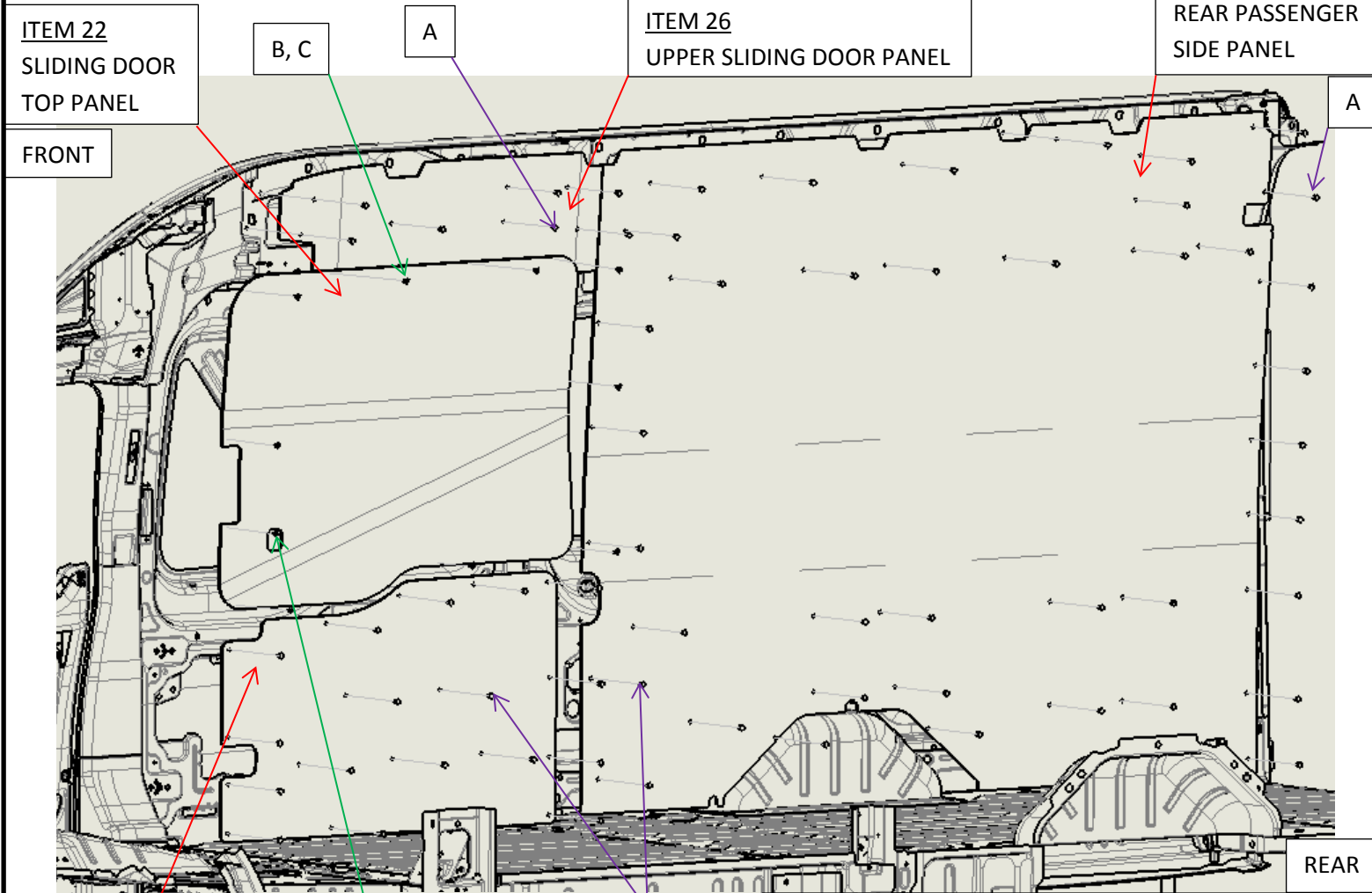

**ITEM 23**  
SLIDING DOOR  
BOTTOM PANEL

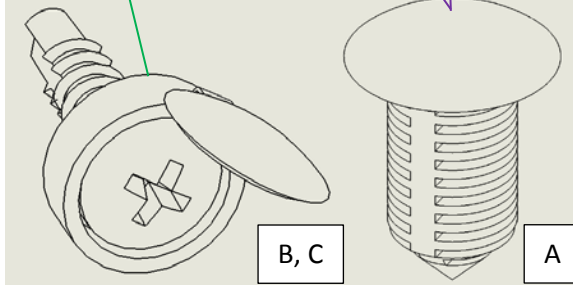

**Installation completed**

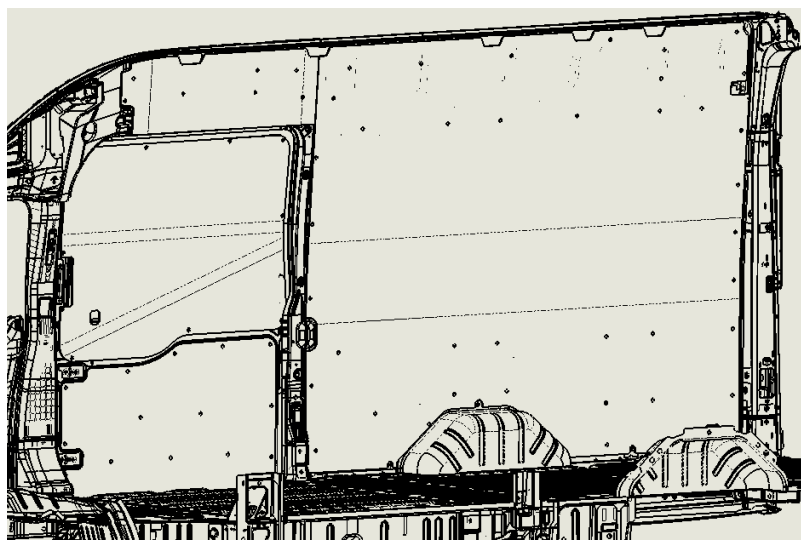

- 4:** Install Item 15, Rear Passenger Side Panel.
- Align wheel well edge of the panel with the feature on the vehicle; position the contour of the panel to the vehicle wall.
  - Install hardware (A), in the holes provided, on the bottom of the panel first, working your way up the panel to the top.
  - Install Item 26, Upper Sliding Door Panel.
  - Install hardware (A), in the holes provided.
- 5:** Install Item 23, Bottom Sliding Door Panel. First remove OEM bottom panel.
- Note: Sliding door must be closed to install panel;
- Insert panel into the sliding door sill cavity, align holes at the bottom half of the panel to the one on the door and insert hardware (A) in all of the holes.
  - Install Item 22, Top Sliding Door Panel with hardware (B, C) in the holes provided; align the panel with the door seal leaving an equal space between the door seal and the panel.

## Ceiling Liner Installation

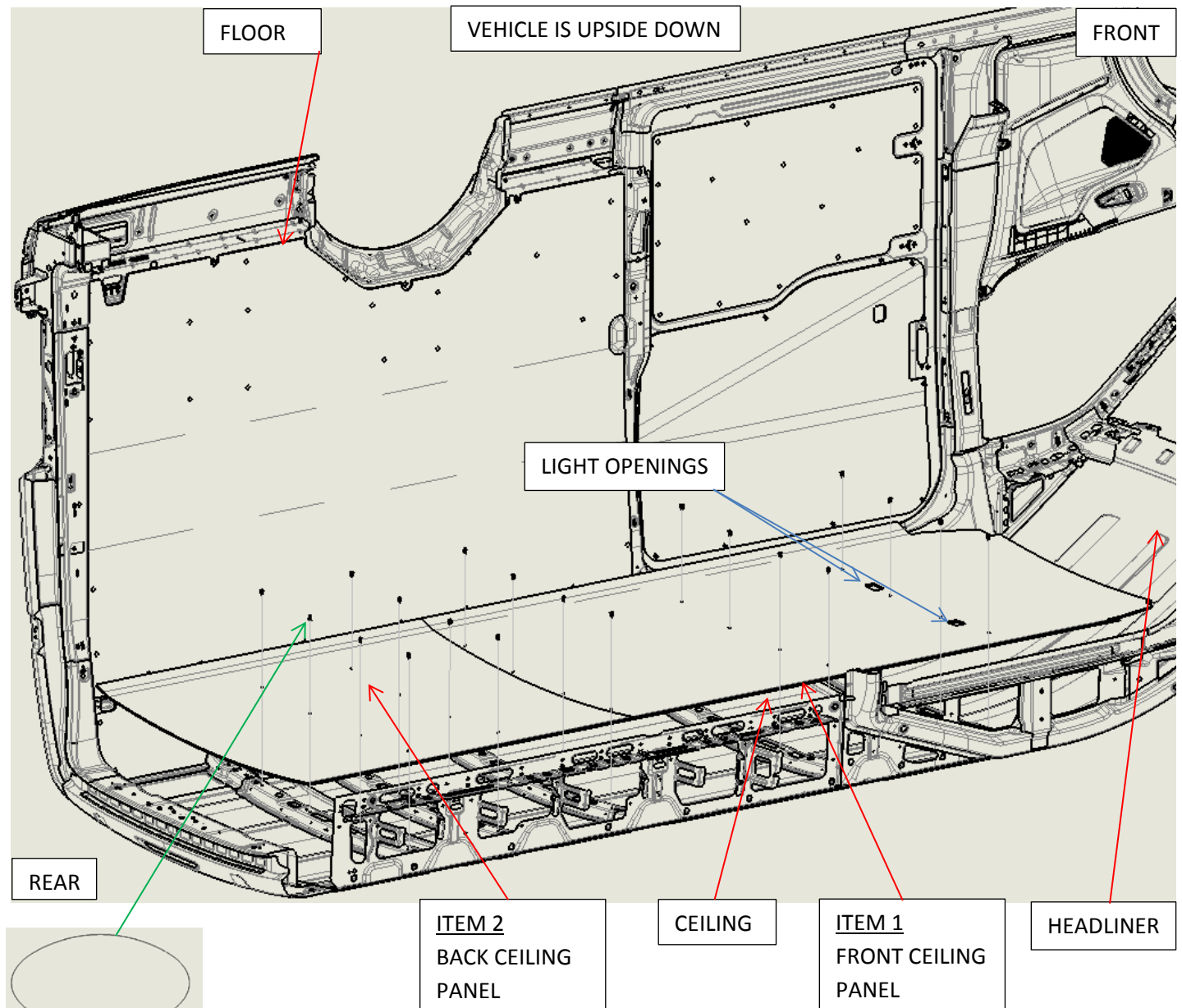

### **6:** Install Item 1, Front Ceiling Panel.

- Align Ceiling panel with the feature on the vehicle in the front, insert the front of the panel between the headliner and the roof, and align the light openings to the lights on the ceiling.
- Align the outside holes at the center of the panel with the holes in the ceiling cross bows and install hardware (A) on each side; this will align the panel with the ceiling.
- Push the panel against the ceiling and install hardware (A), in the holes provided starting from the front working your way towards the rear.
- Install Item 2, Back Ceiling Panel.
- Push the panel against the ceiling and install hardware (A), in the holes provided

## Ceiling Liner Installation

Installation completed

VEHICLE IS UPSIDE DOWN

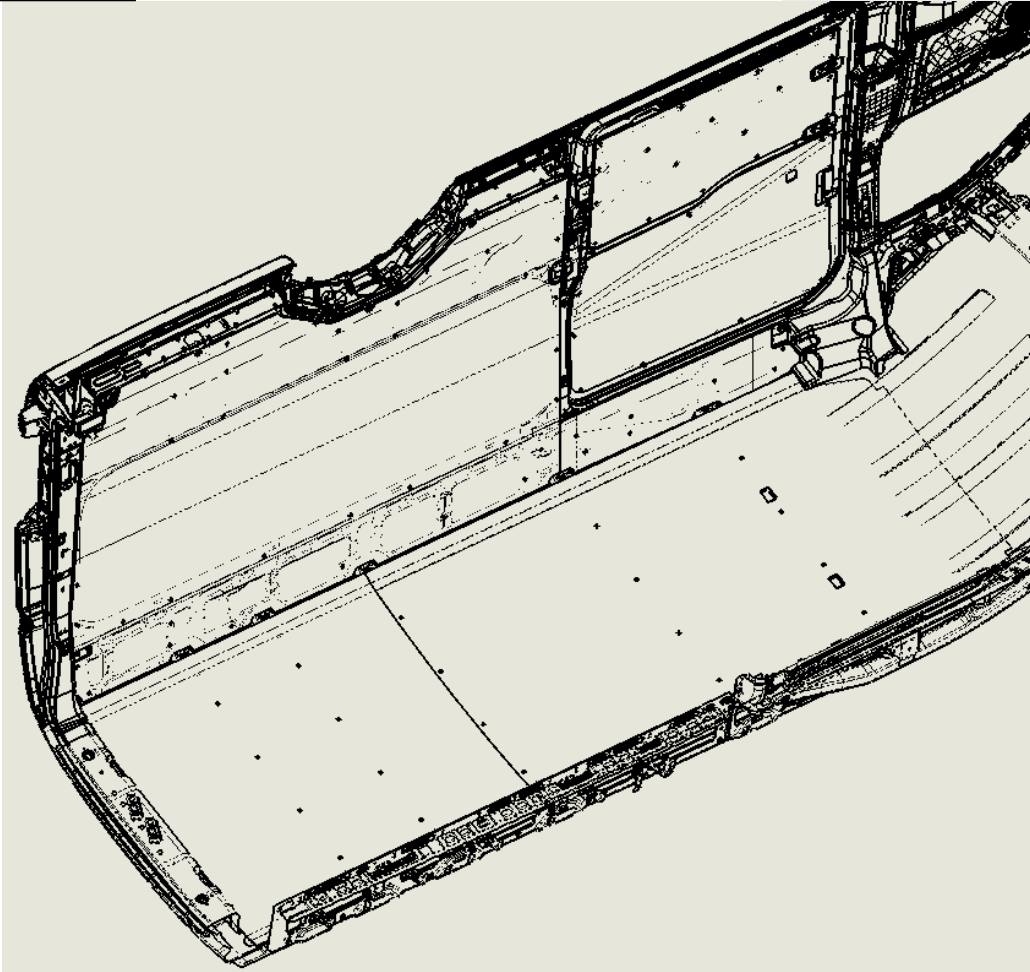

## Ceiling Sills Installation

VEHICLE IS UPSIDE DOWN

PASSENGER SIDE

FRONT

ITEM 7  
CEILING SILL D

WALL

ITEM 5  
CEILING SILL C

CEILING

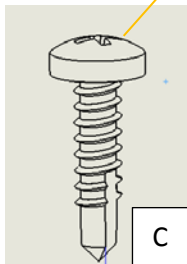

**7:** Assemble Item 4 and item 6 together with the Item 9, Sill Joining Plate (SHOWN BELOW), with hardware (C) in the holes provided.

FOR DRIVER SIDE

- Assemble Item 5 and item 7 together with the Item 9, Sill Joining Plate (SHOWN BELOW), with hardware (C) in the holes provided.

FOR PASSENGER SIDE

- Install the Sill assemblies on the Driver side as well as on the Passenger side using hardware (C) in the holes provided on the Sills.
- First, Install the Sill assembly with hardware (C) on the wall, afterwards install hardware (C) only on the roof cross bows aligned with the retainers holding the ceiling panels.

ITEM 9

SILL JOINING PLATE

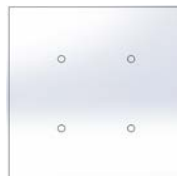



Installation completed

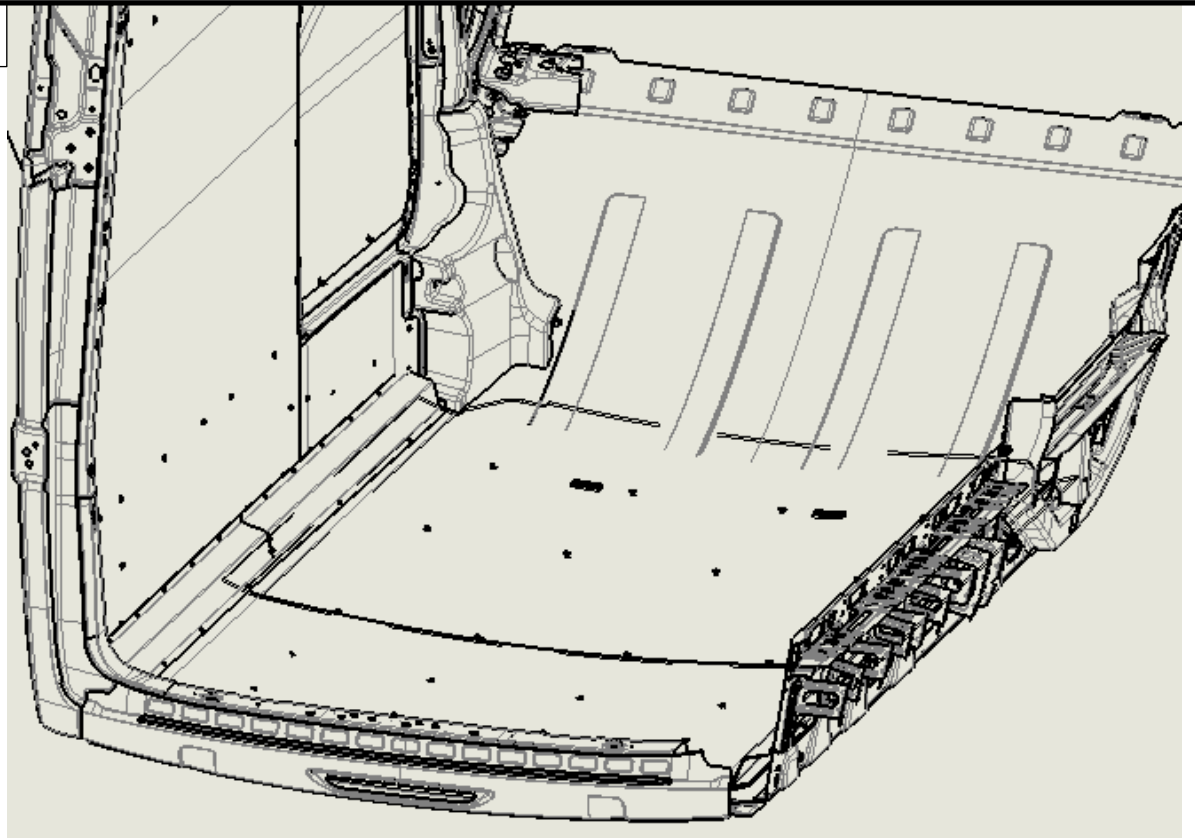

### Ceiling Sills Installation Details

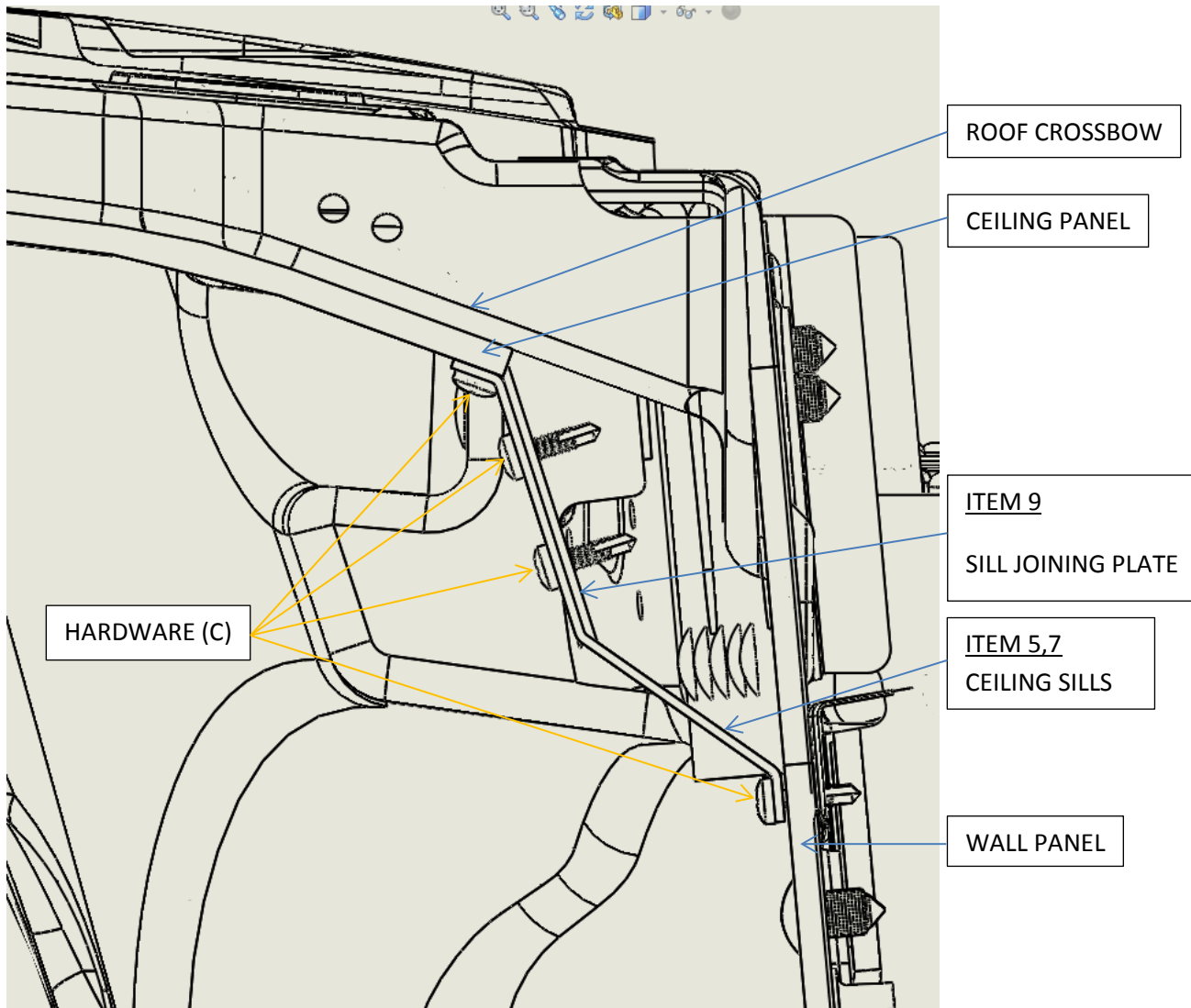

Installation completed

PASSENGER SIDE

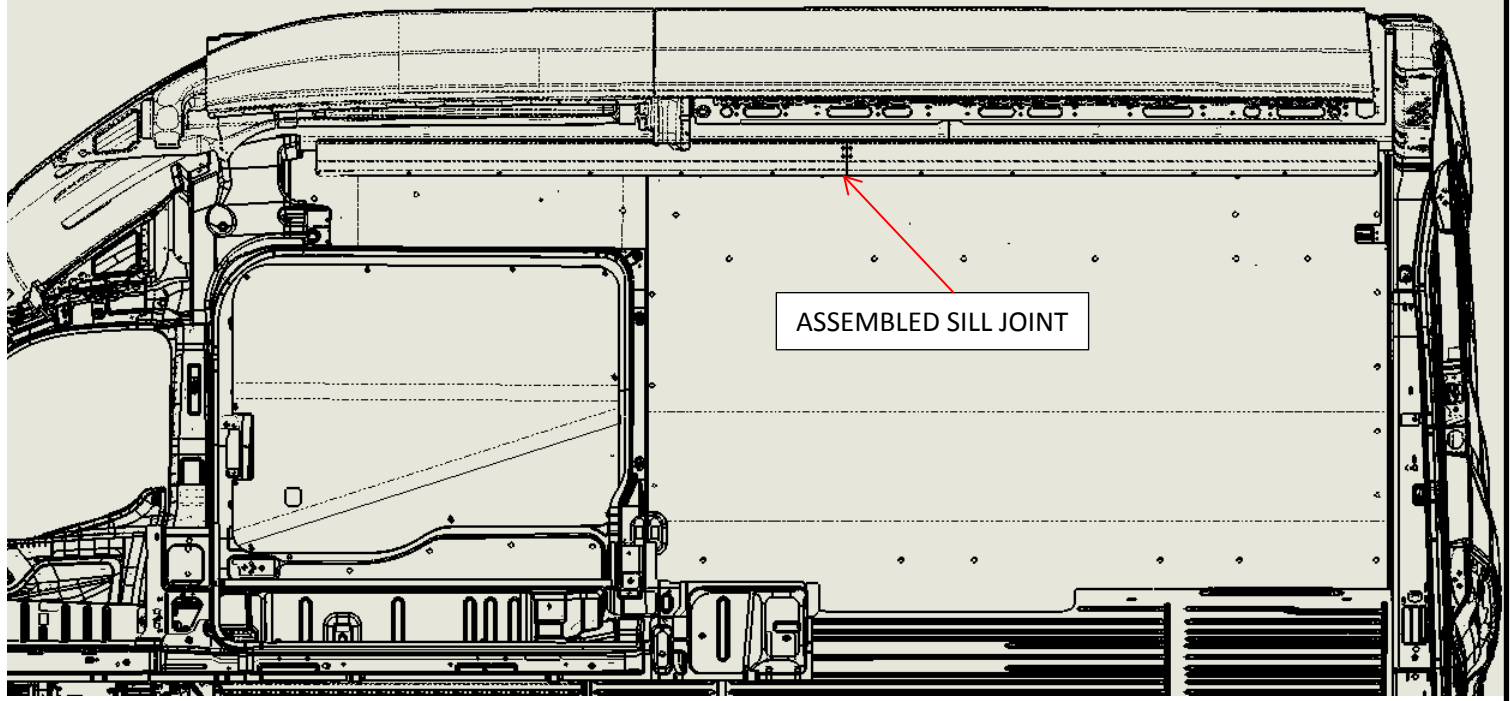

DRIVER SIDE

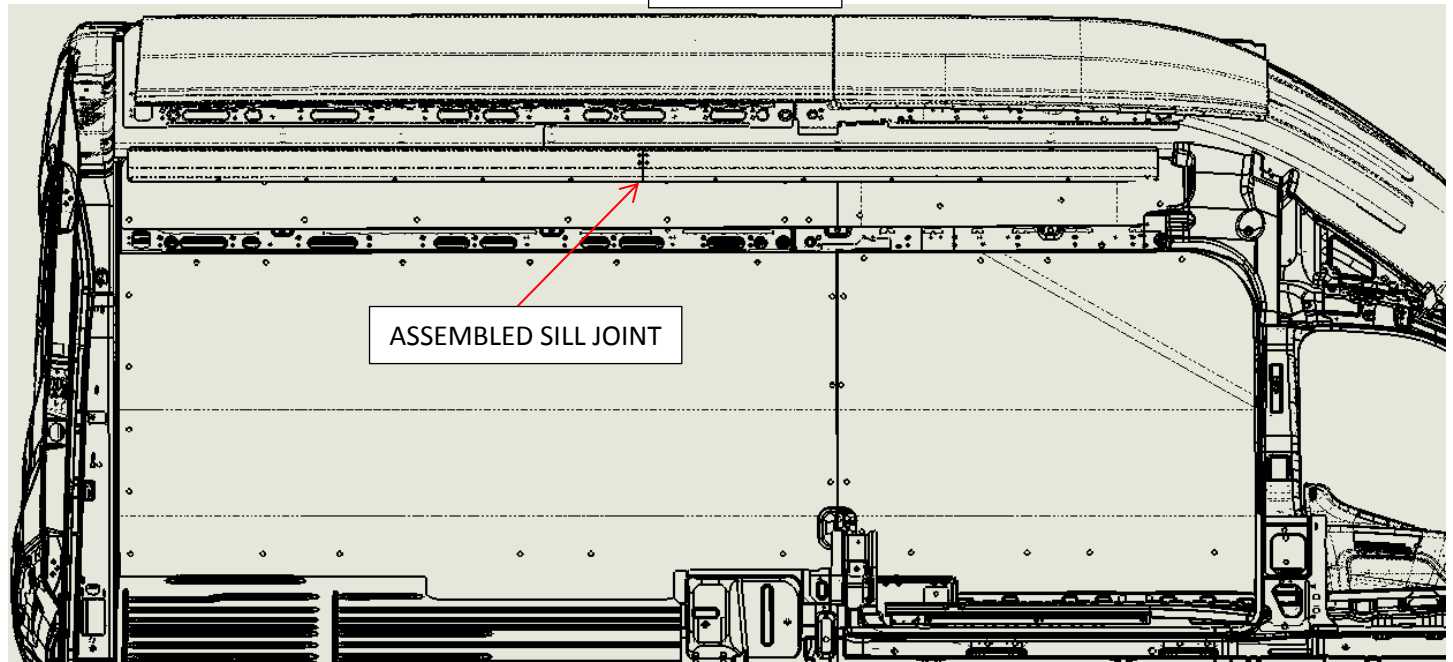

## Floor and Floor Sill Installation

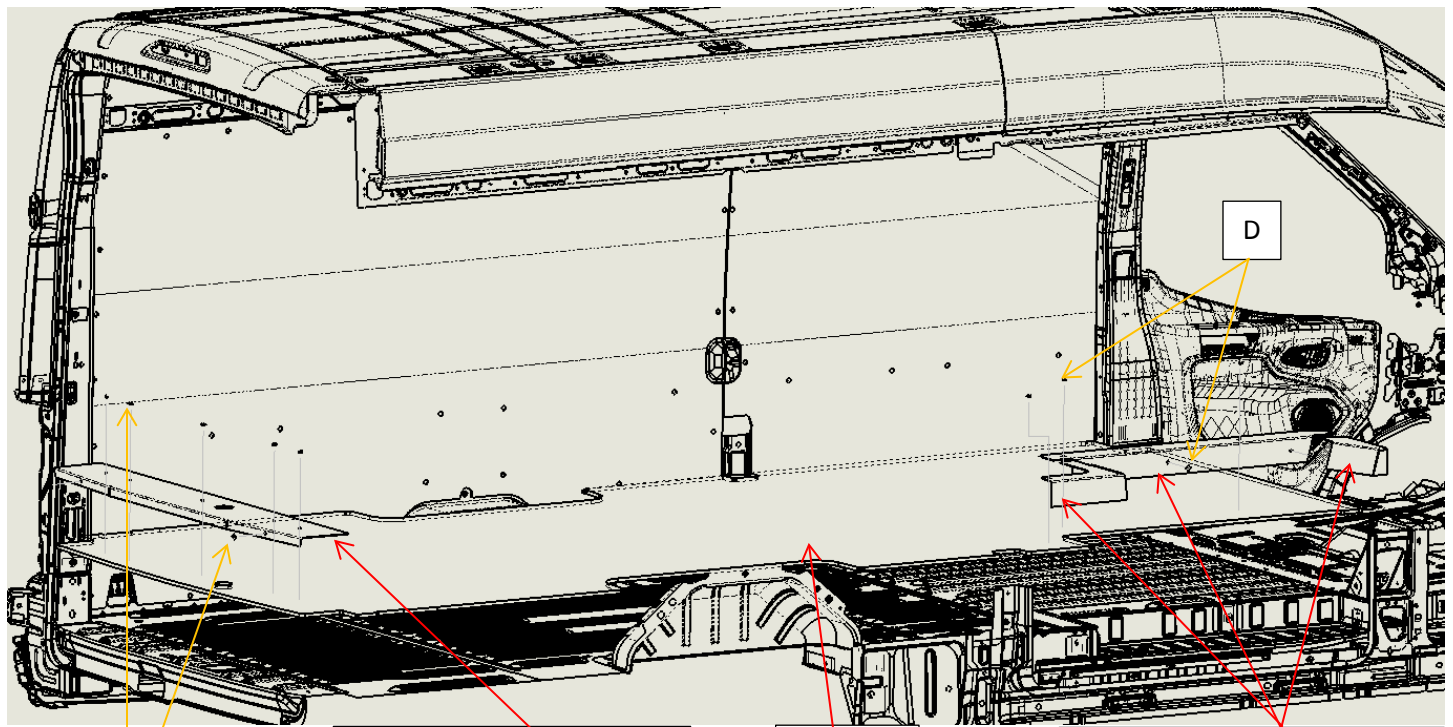

**ITEM 18**  
FLOOR SILL – REAR DOOR

**ITEM 16**  
FLOOR

**ITEM 19, 20, 21**  
FLOOR SILL – SLIDING DOOR

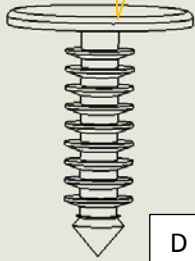

D

**8:** Install Items 16, FLOOR and Items 18, 19, 20, 21 FLOOR SILLS.

- Install floor inside the vehicle.
- Align the floor sills in their proper location with the floor edges and install hardware (D), in the holes provided, if there are no holes drill 6mm holes for each hardware (D).

**Installation completed**

